

LAMOT

VALVE & ARRESTOR

A GROTH CORPORATION BRAND

Installation, Operation & Maintenance of the In-Line Flame Arrestor

Model L76C-UF, Upstream Configuration



TABLE OF CONTENTS

SAFETY WARNINGS	3
INTRODUCTION.....	4
INSTALLATION	4
DESIGN AND FUNCTION	7
MAINTENANCE.....	8
MESG REFERENCE	9
MODEL NUMBER IDENTIFICATION	10
PRODUCT LIMITED WARRANTY	11

SAFETY WARNINGS

DO NOT PIPE DRAINAGE, INSTRUMENTATION, AND/OR CLEANOUT CONNECTIONS TO A COMMON LINE AS THIS CAN PROVIDE A PASSAGE FOR A FLAME TO BY-PASS THE FLAME ARRESTOR ELEMENT. IF THE FLAME WERE TO BE ABLE TO BY-PASS THE FLAME ARRESTOR ELEMENT A FLAME FRONT COULD POTENTIALLY HARM BOTH PROCESS EQUIPMENT AND SITE PERSONNEL.

THE MODEL L76C-UF FLAME ARRESTOR WILL NOT BE EFFECTIVE IN STOPPING FLAME PROPAGATION IN SYSTEMS WHICH CONTAIN VAPORS WITH A MAXIMUM EXPERIMENTAL SAFE GAP (MESG) LESS THAN 0.036" [.90 MM] OR WHEN ANY OF THE OPERATING CONDITIONS STATED HEREIN ARE EXCEEDED.

THE LIFTING EYEBOLTS ON THE ELEMENT HOUSING ARE TO BE USED FOR HANDLING THE HOUSING ONLY DURING INSPECTION AND MAINTENANCE. DO NOT USE THESE EYEBOLTS TO LIFT THE ENTIRE FLAME ARRESTOR. THESE LIFTING EYEBOLTS ARE NOT DESIGNED TO HANDLE THE WEIGHT OF THE ENTIRE ARRESTOR.

BEFORE INSPECTING AND CLEANING THE ARRESTOR, THE CONNECTING PIPELINE MUST BE FREE OF ALL HAZARDOUS OR FLAMMABLE VAPORS. BEFORE DISASSEMBLING ARRESTOR CONSULT MATERIAL SAFETY DATA SHEETS (MSDS) FOR ALL PRODUCTS THAT THE ARRESTOR WAS EXPOSED TO IN SERVICE. THE COMPONENTS SHOULD BE CLEANED ACCORDING TO MSDS PROCEDURE. TAKE APPROPRIATE SAFETY PRECAUTIONS REGARDING EYE PROTECTION, SKIN CONTACT & RESPIRATION.

FLAME SENSING EQUIPMENT IS SUGGESTED FOR VERIFICATION OF A FLAME FRONT. IF A FLAME FRONT IS DETECTED THE GAS SUPPLY NEEDS TO BE STOPPED OR ISOLATED FROM THE ARRESTOR TO PREVENT A FLAME FRONT FROM CONTINUOUSLY BURNING AT THE FLAME ARRESTOR ELEMENT. IF THE FLAME FRONT IS ALLOWED TO BURN AT THE FLAME ARRESTOR ELEMENT, THE FLAME ARRESTOR COULD ALLOW THE FLAME FRONT TO PASS THROUGH THE ELEMENT AND DAMAGE EQUIPMENT AND/OR PERSONNEL ON THE PROTECTED SIDE OF THE ARRESTOR.

THE MODEL L76C-UF FLAME ARRESTOR MAY BE EXPOSED TO INSTANTANEOUS PRESSURE SPIKES. ANY INSTRUMENTATION ATTACHED TO THE ARRESTOR MUST BE CAPABLE OF CONTINUED OPERATION IN THIS ENVIRONMENT.

FAILURE TO REPLACE A DAMAGED FLAME ELEMENT CAN RENDER THE FLAME ARRESTOR INEFFECTIVE. IT IS SUGGESTED THAT A FLAME FRONT DETECTION SYSTEM BE USED TO MONITOR PIPELINE STATUS. IF A FLAME FRONT IS SENSED, IT IS SUGGESTED THAT THE FLAME ARRESTOR ELEMENT BE CHECKED FOR ANY DAMAGE CAUSED BY THE FLAME FRONT.

NEVER STRIKE A FLAME ARRESTOR IN AN ATTEMPT TO BREAK LOOSE BOLTING OR THE FLAME ELEMENT. THIS COULD CREATE A SPARK WHICH COULD CREATE A POTENTIAL IGNITION SOURCE.

SAFE USE OF FLAME ARRESTORS IS LIMITED TO HYDROCARBONS. USE OF FLAME ARRESTORS WITH ANY OTHER CHEMICALS MAY REQUIRE FURTHER TESTING.

AFTER INSTALLATION, ALL CONNECTIONS MUST BE INSPECTED FOR VAPOR LEAKAGE. THIS MAY BE ACCOMPLISHED BY STATIC TEST, GAS DETECTOR, OR "BUBBLE" TEST USING LEAK DETECTION SOLUTION.

INTRODUCTION

This manual is intended to provide recommended instructions for the installation, operation and maintenance of the LAMOT Model L76C-UF in-line flame arrester. Any standard procedures and practices developed for a specific plant or process should supersede this manual. Although this manual cannot cover all possible contingencies, following these guidelines will provide safe, reliable flame arrester service.

The arrester shall be treated as a safety device and must be maintained by a knowledgeable repair technician. Carefully read and understand this manual before installing or servicing this product.

For information not contained in this manual, please contact:

Groth Corporation
 13650 N. Promenade Blvd.
 Stafford, TX, 77477 USA
 Phone: 281-295-6800
 Fax: 281-295-6999
www.grothcorp.com

INSTALLATION

APPLICATION LIMITATIONS

LAMOT Model L76C-UF threaded in-line flame arrestors are suitable for in-line low-pressure atmospheric deflagrations, with short burn times, and are designed and tested to operate within the following maximum operating conditions.

For an arrester to be properly installed in a given application, **all** the requirements for one of the two following configuration scenarios must be met:

1. Straight Pipe, Closed End Configuration:									
Model	Connection Size (mm)	Housing Size (mm)	Gas Group	End Condition(s) Allowed	Allowable Bend(s)*	Maximum Pipe Length from Ignition Source to Flame Arrester**	Maximum Operational Pressure	Maximum Burn Time at Atmospheric Pressure	Operational Temperature Range °F (°C)
L76C-UF-0206	2" (50 mm)	6" (150 mm)	IIA (D)	Closed or Open End	None	50 pipe diameters	20.3 psia (1.40 bara)	3.5 minutes	-4 to 140 (-20 to 60)
L76C-UF-0308	3" (80 mm)	8" (200 mm)	IIA (D)	Closed or Open End	None	50 pipe diameters	20.3 psia (1.40 bara)	3 minutes	-4 to 140 (-20 to 60)
L76C-UF-0410	4" (100 mm)	10" (250 mm)	IIA (D)	Closed or Open End	None	50 pipe diameters	17.4 psia (1.20 bara)	2.5 minutes	-4 to 140 (-20 to 60)
L76C-UF-0616	6" (150 mm)	16" (400 mm)	IIA (D)	Closed or Open End	None	50 pipe diameters	18.8 psia (1.30 bara)	3 minutes	-4 to 140 (-20 to 60)
L76C-AF-0820	8" (200 mm)	20" (500 mm)	IIA (D)	Closed or Open End	None	50 pipe diameters	18.8 psia (1.30 bara)	3 minutes	-4 to 140 (-20 to 60)
L76C-AF-1020	10" (250 mm)	24" (600 mm)	IIA (D)	Closed or Open End	None	50 pipe diameters	18.8 psia (1.30 bara)	3 minutes	-4 to 140 (-20 to 60)
L76C-AF-1228	12" (300 mm)	28" (700 mm)	IIA (D)	Closed or Open End	None	50 pipe diameters	18.8 psia (1.30 bara)	3 minutes	-4 to 140 (-20 to 60)

Model L76C-UF, Straight Pipe, Closed End Configuration, is designed and tested according to EN ISO 16852:2016, except for:
 1. The short time burn test was conducted at atmospheric pressure, for a time period extending past 1 minute.

***No additional bends or restrictions are allowed. Bends and flow restrictions can cause additional turbulence, which can increase the intensity of the flame propagation; potentially compromising the performance of the flame arrester.**

**See below *Figure 1*, Straight Pipe configuration diagram:

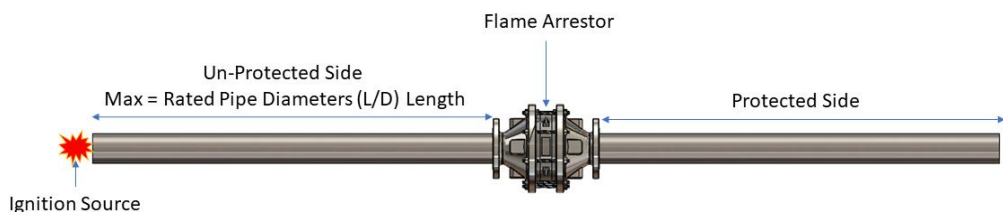

Figure 1: Straight Pipe, Allowable Installation Configuration

2. Configuration with Bend, Open End Only Configuration:

Model	Connection Size (mm)	Housing Size (mm)	Gas Group	End Condition Allowed	Allowable Bend(s)*	Maximum Pipe Length from Ignition Source to Flame Arrestor** (ignition source - max of "A" ft - bend - max of "B" ft - arrester)	Maximum Operational Pressure	Maximum Burn Time at Atmospheric Pressure	Operational Temperature Range °F (°C)
L76C-UF-0206	2" (50 mm)	6" (150 mm)	IIA (D)	Open End	One 90 degree	20 ft total length: A = max of 15 ft B = max of 5 ft	15.5 psia (1.07 bara)	3.5 minutes	-4 to 140 (-20 to 60)
L76C-UF-0308	3" (80 mm)	8" (200 mm)	IIA (D)	Open End	One 90 degree	20 ft total length: A = max of 15 ft B = max of 5 ft	15.5 psia (1.07 bara)	3 minutes	-4 to 140 (-20 to 60)
L76C-UF-0410	4" (100 mm)	10" (250 mm)	IIA (D)	Open End	One 90 degree	20 ft total length: A = max of 15 ft B = max of 5 ft	15.9 psia (1.10 bara)	2.5 minutes	-4 to 140 (-20 to 60)
L76C-UF-0616	6" (150 mm)	16" (400 mm)	IIA (D)	Open End	One 90 degree	25 ft total length: A = max of 20 ft B = max of 5 ft	17.4 psia (1.20 bara)	3 minutes	-4 to 140 (-20 to 60)
L76C-UF-0820	8" (200 mm)	20" (500 mm)	IIA (D)	Open End	One 90 degree	26 ft total length: A = max of 20 ft B = max of 6 ft	17.4 psia (1.20 bara)	3 minutes	-4 to 140 (-20 to 60)
L76C-UF-1020	10" (250 mm)	24" (600 mm)	IIA (D)	Open End	One 90 degree	33 ft total length: A = max of 25 ft B = max of 8 ft	17.4 psia (1.20 bara)	3 minutes	-4 to 140 (-20 to 60)
L76C-UF-1228	12" (300 mm)	28" (700 mm)	IIA (D)	Open End	One 90 degree	40 ft total length: A = max of 30 ft B = max of 10 ft	17.4 psia (1.20 bara)	3 minutes	-4 to 140 (-20 to 60)

Model L76C-UF, Configuration with Bend, Open End Configuration, is designed and tested according to EN ISO 16852:2016, except for:

1. The piping on the unprotected side, consisted of ignition source, "A" ft of straight pipe, one 90 degree bend, "B" ft of straight pipe, then the arrester.

2. The short time burn test was conducted at atmospheric pressure, for a time period extending past 1 minute.

***No additional bends or restrictions are allowed. Bends and flow restrictions can cause additional turbulence, which can increase the intensity of the flame propagation; potentially compromising the performance of the flame arrester.**

****See below Figure 2, Configuration with bend diagram:**

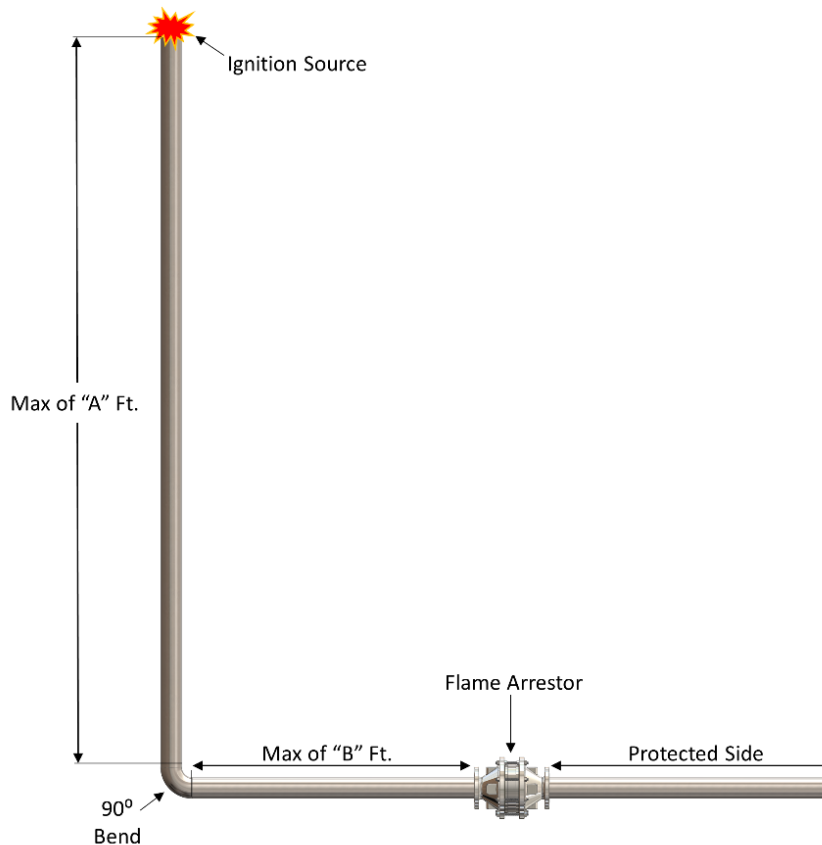

Figure 2: Configuration with Bend, Allowable Installation Configuration

 **WARNING!**

STABILIZED BURNING

Unlimited stabilized burning should not be allowed for this model flame arrestor. If stabilized burning for a period exceeding half of the burn time is possible, a temperature activated shutdown system and temperature alarm should be installed.

INITIAL INSTALLATION

Based on the testing conditions, this series of In-line deflagration flame arrestor may be installed in piping systems where:

1. All the parameters shown in either of the two tables on page 4 & 5 “1. Straight Pipe, Closed End Configuration” & “2. Configuration with Bend, Open End Only Configuration:” are met.
2. The piping system in which the deflagration arrestor is to be installed does not exceed the arrestor flange size.

 **WARNING!**

PIPING REDUCTIONS & EXPANSIONS

The L76C threaded in-line deflagration arrestor may NOT be effective in stopping flame propagation in systems which have a piping reduction or expansion.

All LAMOT in-line deflagration flame arrestors are bi-directional and can be used in vertical or horizontal piping systems. However, if installed in a horizontal orientation, care must be taken if gas service has possibility of having liquid drop out. If liquid condensation is possible, a method of removing the liquid prior to the arrestor should be implemented to avoid pressure drop and potential failure.

This series of flame arrestors are available to mate with 150# ASME class flanges. Please follow the torque guidelines listed in Table 3 for flange make-up torque.

The following guidelines should be observed at installation:

1. Remove any flange protectors and discard all packing material.
2. Inspect the gasket seating surface of the mating flanges. It must be clean, flat and free of scratches, corrosion and tool marks.
3. Inspect the gasket; make sure that the material is suitable for the application.
4. Lubricate all studs and nuts with an appropriate thread lubricant. If the arrestor will see high temperature service or stainless steel fasteners are used, select an anti-seize compound such as moly-disulfide.
5. Center the gasket within the bolt circle.
6. Set the arrestor on its mating flange or nozzle. Position the lifting handles/lifting eyes and jacking nuts/screws to facilitate future removal of the flame arrestor housing. Position the drain and instrument ports to provide proper access and function. (See Maintenance Instructions). Install the studs and tighten nuts hand tight.

Table 3 PIPE FLANGE STUD TORQUE CHART Ft-Lb (N-m)		
Size Inches (mm)	ASME 150#	
	FF	RF
2" (50mm)	60 (82)	60 (82)
3" (80mm)	60 (82)	60 (82)
4" (100mm)	60 (82)	60 (82)
6" (150mm)	105 (143)	105 (143)
8" (200mm)	105 (143)	105 (143)
10" (250mm)	140 (190)	170 (231)
12" (300mm)	140 (190)	170 (231)

(Torque is an average value based on a nitrile binder synthetic gasket, 1/32" thick and lubricated threads).

7. Torque all fasteners to half the value listed in Table 3 in a cross torquing pattern to provide an evenly compressed gasket joint.
8. Make up the final torque and check that no further nut rotation occurs at the specified torque value.
9. Check flange connection for leaks, to assure that the flanged connection is properly sealed.

DESIGN AND FUNCTION

LAMOT 's in-line flame arrestors are designed to prevent flame propagation in gas piping systems that contain flammable gas/vapor mixtures. The arrestor must prevent flame passage under certain specified conditions while permitting free flow of gas/vapor through the system. Thus, it protects vulnerable equipment or components of the system from damage due to explosive pressures caused by gas/vapor ignition in another part of the system. The flame arrestor must be used under only those operating conditions for which it was designed and tested.

The flame arrestors consist of two main components: the arrestor bases and the flame bank element housing assembly. The bases serve as the connecting interface to the piping system. The housing retains and supports the flame element. Both components are essential in stopping the passage of the flame.

The flame element is comprised of small parallel passageways aligned so that an approaching flame front is slowed down and then quenched before it can propagate to the protected side of the device. All LAMOT flame elements utilize spiral wound, crimped ribbon constructed of corrosion resistant materials, to ensure the best flame quenching performance with minimum pressure drop. The element is supported by rigid beams on a wheel in the housing, to withstand a low-pressure deflagration.

WARNING!

Any damage to the flame arrestor element, can compromise the ability of the flame arrestor to stop a flame front within the arrestor performance design specifications. This damage can be caused by, but not limited to: dropping the arrestor, dropping something on the flame element, improper cleaning practice with high pressure fluid, forcing something into the flame element gaps, etc...

WARNING!

It is not recommended to remove the flame element from the arrestor element housing, as this can cause damage to the element or open up gaps around the flame element, which could compromise the flame-stopping performance of the flame arrestor.

The bases must also withstand the deflagration pressures while conveying the burning vapors and flame front to the element. Depending on the design of the system in which it is used, the arrestor bases can include optional ports for thermocouples or pressure monitoring devices.

MAINTENANCE

For maximum operating efficiency, the element of a flame arrestor must be inspected and maintained at regular intervals. Frequency of inspection should be based on the experience gained in each application. Inspection of wetted components is recommended at least once per year or any time that one of the following conditions occur:

- Excessive pressure drop is encountered at a known flow rate.
- A flame front is detected.

Maintenance is accomplished by removing the element assembly for inspection and cleaning or replacement.

⚠ WARNING!

After a flame event has occurred, it is recommended that the flame arrestor element assembly be replaced. No guarantees are offered for flame arrestor performance after the first flame event.

1. When removing the element housing for maintenance, support the weight by attachment to the housing handles, or lifting eyes, and proceed as follows.
2. Loosen the hex bolting nuts.
3. Use the separating nuts, if necessary, to separate the two bases from one-another so as to allow for the housing to be removed. Use spacer blocks or spreader tools, if necessary, to safely secure the base halves so the housing is free for removal.
4. Carefully remove the flame bank element housing assembly for inspection. The flame element and supporting grids shall be visually inspected for damage or corrosion build-up from both sides. If the flame element appears to be damaged, it should be replaced immediately with a new one.

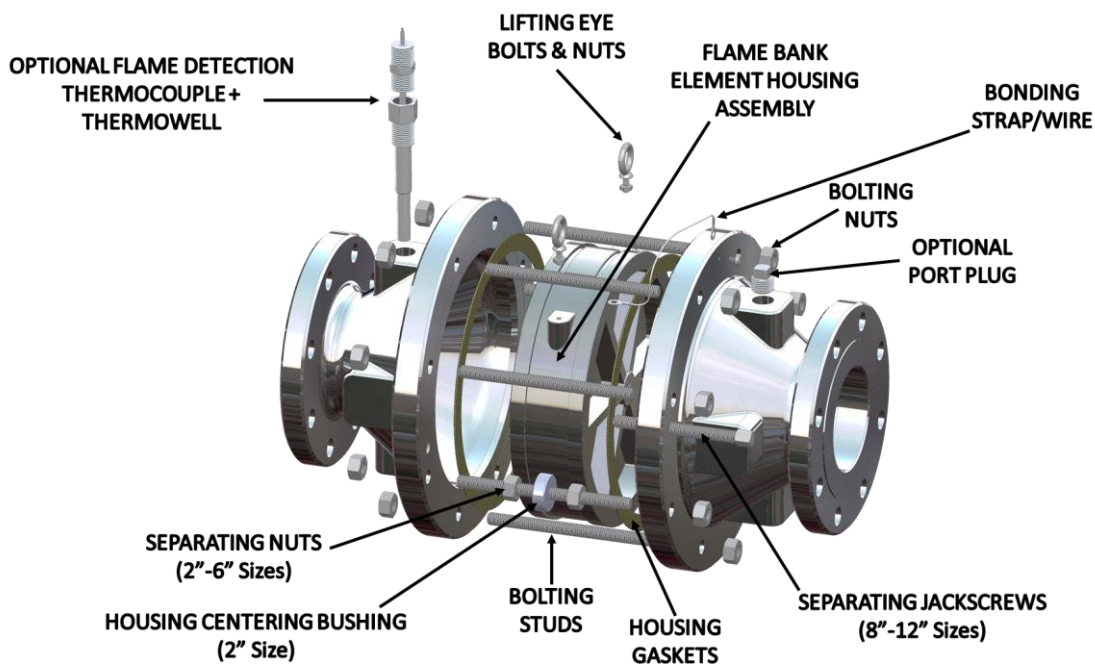

CAUTION

In a horizontal line, the flame bank assembly should be supported before removing the studs. Use structures and equipment suitable for supporting the component's weight.

5. Verify that the element openings are not obstructed by viewing a light source through the element passages. If the flame element is dirty it can be cleaned by one of the following methods:
 - Compressed air, ≤ 80 psig shop air.
 - High pressure steam, although not in a focused stream which could damage the element.
 - Water purge, using a low-pressure "garden hose" spray nozzle; ≤ 40 psig water pressure.

- Non-flammable solvent wash, followed by compressed air until dry.

⚠ WARNING!

Never try to clean the element by inserting a sharp tool or probe into the orifices. Any damage to the integrity of these passages can render the flame arrestor ineffective.

6. Inspect the sealing gasket for damage and replace if necessary.
7. Lubricate all studs and nuts with an appropriate thread lubricant. If the arrestor will see high temperature service or stainless steel fasteners are used, select an anti-seize compound such as moly-disulfide.
8. Reassemble the housing, bases and gaskets. The counterbores will position the housing on the base centerline. Insert the studs and torque all fasteners to half the value listed in Table 2 in a cross torquing pattern to provide an evenly compressed gasket joint.
9. Make up the final torque and check that no further nut rotation occurs at the specified torque value. The torque values are based on original gaskets supplied by LaMot Valve & Arrestor.

Table 2 HOUSING STUD TORQUE CHART	
SIZE (Connection Size x Housing Size) Inches (mm)	TORQUE
	Ft-Lb (N-m)
2" x 6" (50mm x 150mm)	30 (41)
3" x 8" (80mm x 200mm)	35 (47)
4" x 10" (100mm x 250mm)	45 (61)
6" x 16" (150mm x 400mm)	80 (108)

MESG REFERENCE





The Maximum Experimental Safe Gap (MESG) is defined as the distance between parallel surfaces that will prevent the propagation of any gas-air mixture on one side of the gap from igniting the mixture of the same gases on the other side.

⚠ WARNING!

It is vital to correct installation and operation of the flame arrestor that it is installed for use within the appropriate gas grouping and MESG.

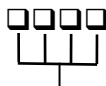
You should research your process gas/vapor and confirm that it is classified in the correct IIA gas grouping, and the MESG is greater than or equal to 0.90 mm (0.036"). Gas grouping classifications and MESG values are published by several standards agencies; including, but not limited to, NFPA 497 (Table 4.4.2, 2017 edition) and the United States Coast Guard (USCG). Please work with your engineering department to determine the correct gas group classification of your process gas/vapor in which the flame arrestor will be installed.

MODEL NUMBER IDENTIFICATION

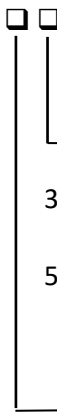
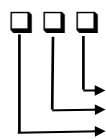
MODEL#	TESTING CONFIGURATION	NOMINAL CONNECTION SIZE	NOMINAL HOUSING SIZE	MATERIAL	PORT OPTIONS*
 L76C	 UF = UPSTREAM CONFIGURATION	 02" Thru 12"	 06" Thru 28"	 <p>Flame Element Housing & Winding Material: 3 = Carbon Steel Housing & 316 SS Element 5 = 316 SS Housing & 316 SS Element</p> <p>Bases Material: 3 = Carbon Steel 5 = 316 SS</p>	 <p>O = No Options T = Integrated Temp Sensor Thermocouple Type K (outlet only)</p> <p>2 = 1/2" NPT Ports (inlet & outlet base)</p> <p>3 = 3/4" NPT Ports (inlet & outlet base)</p>
NOTES:		Include model number when ordering.			
		*For additional & special options, consult factory			
EXAMPLE: L76C - UF- 0206 - 33 - 020					
<i>Indicates a LaMOT Model L76C, Upstream Configuration, 2" ASME 150# Connection, with 6" Housing Size, Carbon Steel Bases, Carbon Steel Housing with 316 SS Flame Element, 1/2" NPT Pressure Tap Ports (in Position "B") on both Inlet & Outlet Bases</i>					

PRODUCT LIMITED WARRANTY

Only Groth's Product Limited Warranty terms apply to purchase orders accepted by Groth Corporation for LAMOT products.

Seller warrants that products which are manufactured by Seller, are manufactured in accordance with published specifications and free from defects in materials and/or workmanship for a period of (12) twelve months. Seller, at its option, will repair or replace any products returned intact to the factory, transportation charges prepaid, which Seller, upon inspection, shall determine to be defective in material and/or workmanship. The foregoing shall constitute the sole remedy for any breach of Seller's warranty.

THERE ARE NO UNDERSTANDINGS, AGREEMENTS, REPRESENTATIONS, OR WARRANTIES, EXPRESS OR IMPLIED, (INCLUDING MERCHANTABILITY OR FITNESS FOR A PARTICULAR PURPOSE REGARDING PRODUCTS) UNLESS SPECIFIED IN THE SALES CONTRACT. THIS CONTRACT STATES THE ENTIRE OBLIGATION OF SELLER.

Seller makes no warranties, either express or implied, except as provided herein, including without limitation thereof, warranties as to marketability, merchantability, for a particular purpose or use, or against infringement of any patent of products. In no event shall Seller be liable for any direct, incidental or consequential damages of any nature, or losses or expenses resulting from any defective new product or the use of any such product, including any damages for loss of time, inconvenience, or loss of use of any such product.

The original Manufacturer shall be solely responsible for the design, development, supply, production, and performance of its products hereunder, and the protection of its trade name or names, if any. It assumes no responsibility, for products modified or changed in any way by its agent or customer. Any such modifications or changes to products sold by Seller hereunder shall make the product limited warranty null and void.

The Manufacturer shall be under no obligation to manufacture, sell, or supply, or to continue to manufacture, sell or supply any of the Products.

Groth assumes no responsibility for products modified or changed by Customer or any other third party. Any such modifications or changes to products sold by Groth hereunder shall make the product limited warranty null and void. Groth shall be under no obligation to manufacture, sell or supply, or to continue to manufacture, sell, or supply any of the products.

LAMOT® Valve & Arrestor has representatives throughout North America.
Contact us or visit us on the web for the authorized representative in your area.



A GROTH CORPORATION BRAND

GROTH CORPORATION

13650 N Promenade Blvd
Stafford, TX 77477

phone: 281-295-6800
fax: 281-295-6999
toll-free: 800-354-6844
e-mail: ValveSales@lamot.com
website: www.lamot.com